

# An Automatic Machine Tool

*Feedback control has begun to advance in the working of metals. Presenting the first account of a milling machine that converts information on punched tape into the contours of a finished part*

by William Pease

THE metal-cutting industry is one field in which automatic control has been late in arriving. The speed, judgment and especially the flexibility with which a skilled machinist controls his machine tool have not been easily duplicated by automatic machines. Only for mass-production operations such as the making of automobile parts has it been feasible to employ automatic machinery. New developments in feedback control and machine computation, however, are now opening the door to automatization of ma-

chine tools built to produce a variety of parts in relatively small quantities.

The problem will be clearer if we first review briefly the history of machine tools and their relationship to manufacturing processes. The story begins in the last quarter of the 18th century. Prior to that time the tools of the millwright, as the machinist of that day was called, consisted chiefly of the hammer, chisel and file. His measurements were made with a wooden rule and crude calipers. His materials were prepared either by hand-forging or by

rudimentary foundry casting. Crude, hand-powered lathes were already in existence, but they were used only for wood-turning or occasionally for making clock parts.

The first machine tool in the modern sense of the word was a cylinder-boring device invented in 1774 by John Wilkinson. Wilkinson is by no means as well-remembered as James Watt, but it was his invention that enabled Watt to build a full-scale steam engine. For 10 years Watt had been struggling vainly to turn out a cylinder true enough for

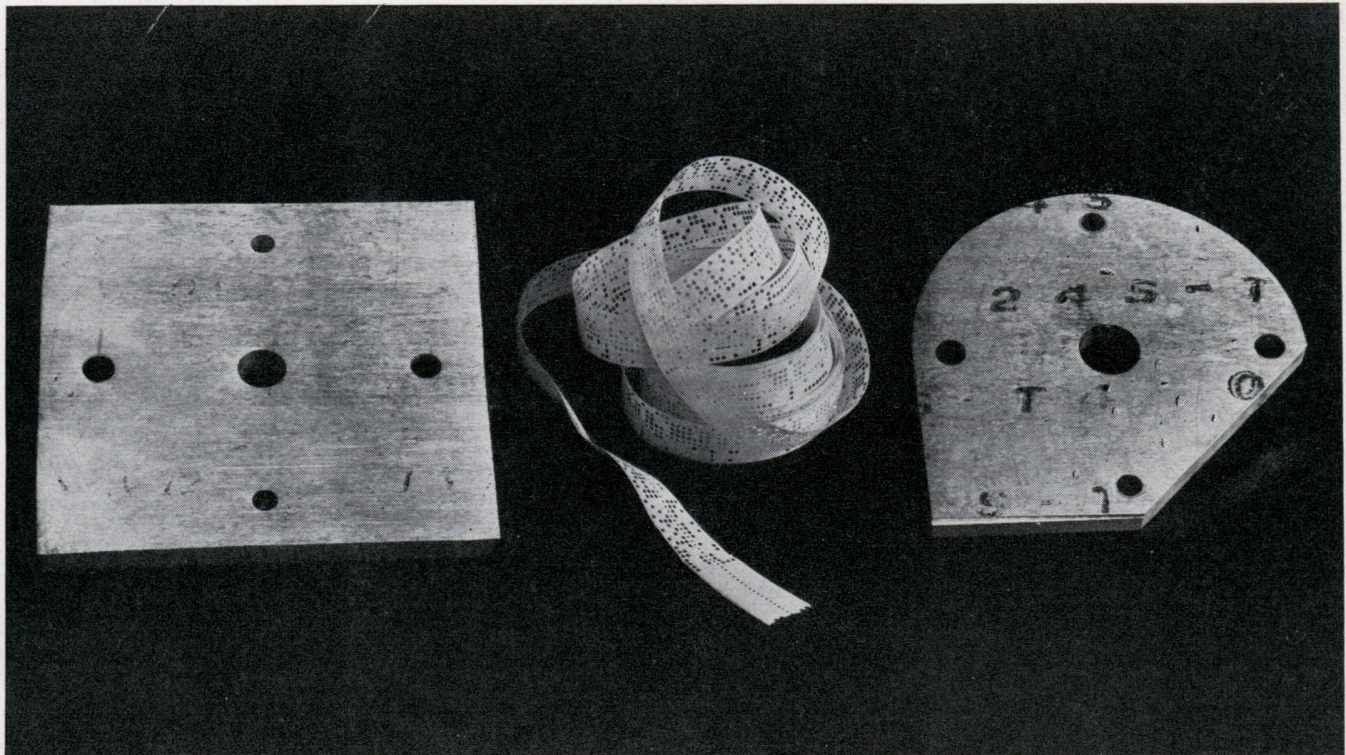

**SAMPLE PRODUCT** of the automatic machine tool described in this article is the cam shown at right.

The instructions which direct the cutting of the cam from a square blank are encoded on paper tape.

the job. After one effort he reported in discouragement that in his cylinder of 18-inch diameter "at the worst place the long diameter exceeded the short by three-eighths of an inch." But in 1776 Watt's partner, Matthew Boulton, was able to write: "Mr. Wilkinson has bored us several cylinders almost without error; that of 50 inches diameter, which we have put up at Tipton, does not err the thickness of an old shilling in any part." The importance of Wilkinson's boring machine cannot be overesti-

ated. It made the steam engine a commercial success, and it was the forerunner of all the large, accurate metal-working tools of modern industry.

Another productive Englishman of the same period was Joseph Bramah. His inventions included one of the most successful locks ever devised, the hydraulic press, various woodworking machines, the four-way valve, a beer pump and the water closet. To manufacture his inventions he and an associate, Henry Maudslay, created several metal-

cutting machines. The most significant of these was a screw-cutting lathe with a slide rest and change gears remarkably like our modern lathes.

**T**HE NEXT great step forward in machine technology was pioneered by Eli Whitney. Although he is remembered mainly as the inventor of the cotton gin, his greatest contribution was an innovation of much more general import: interchangeability of manufactured parts. In 1798 Whitney, hav-

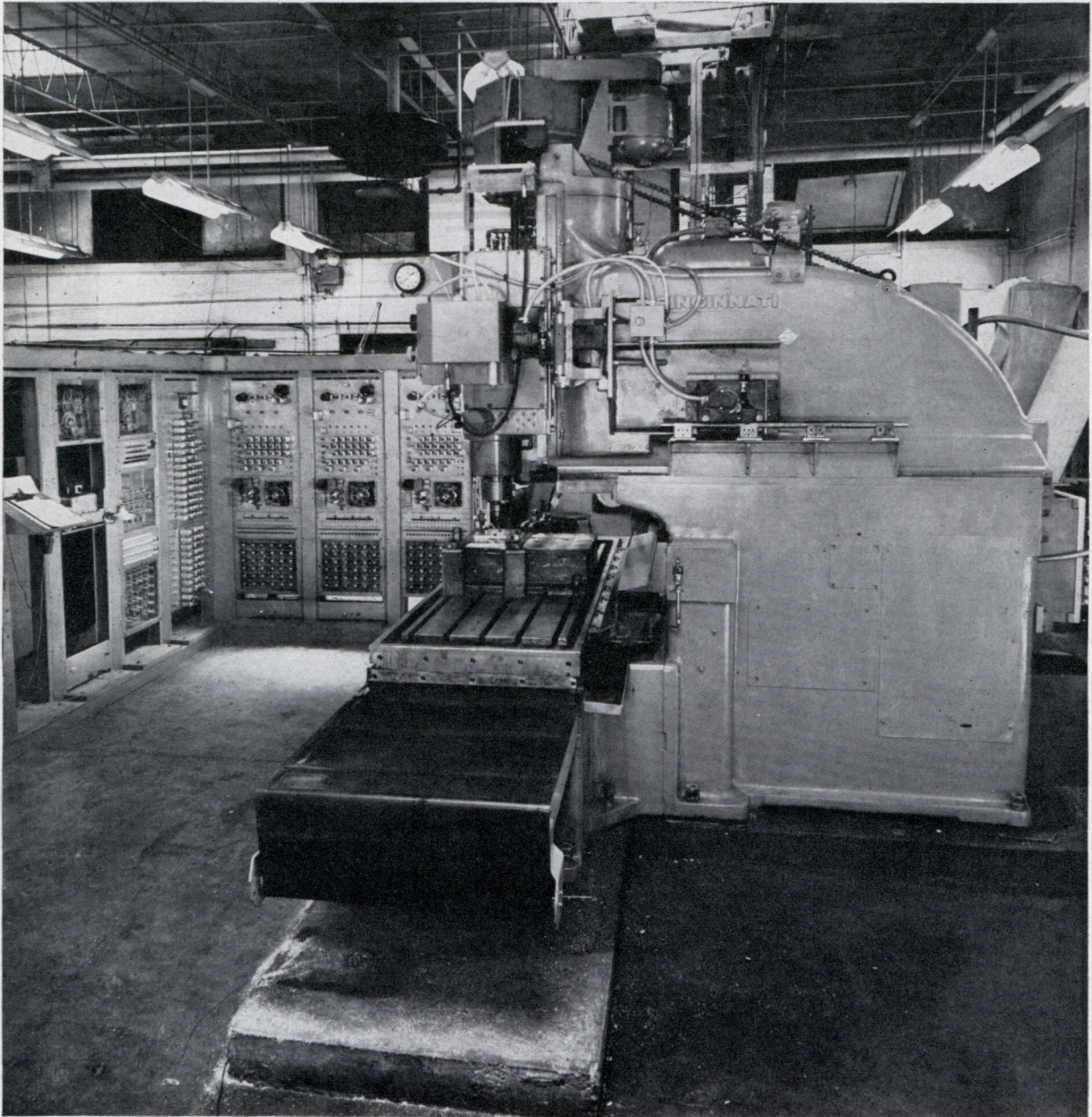

**MACHINE AND CONTROL** are shown here in entirety. For details of the control panels (*left*) see pages 104 and 105. The machine has universal motion: the "head," holding the cutting tool, moves vertically; the "cross

slide" moves the head back and forth across table; the table moves from side to side under tool. The control system coordinates all three motions simultaneously to perform the operations shown on the opposite page.

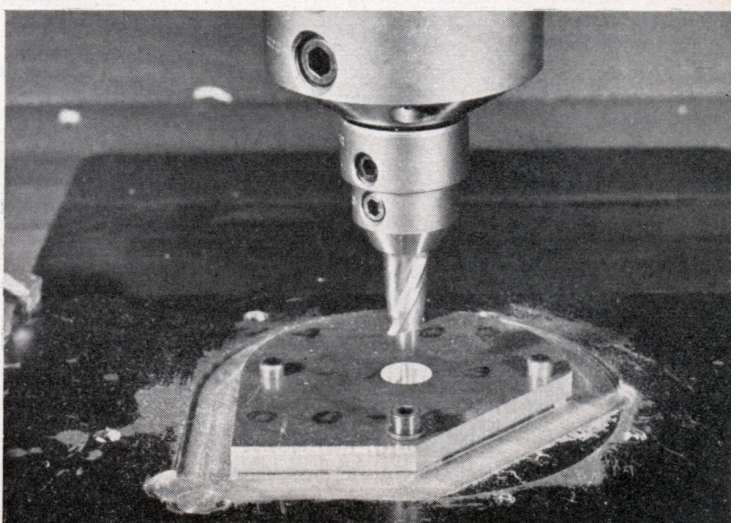
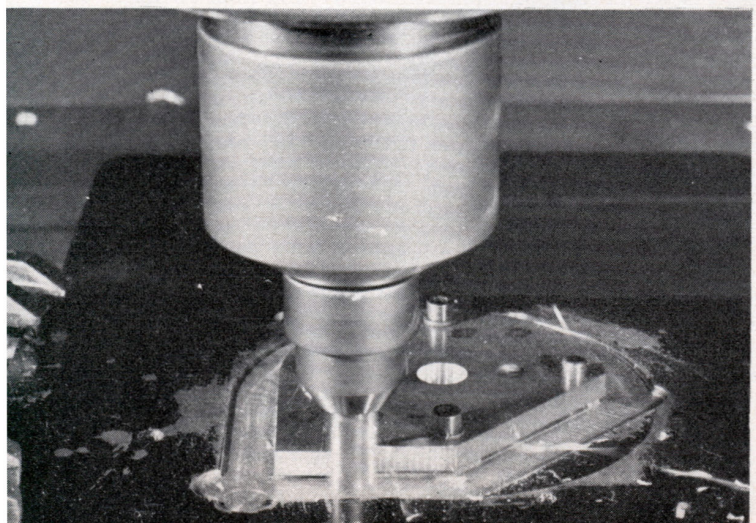
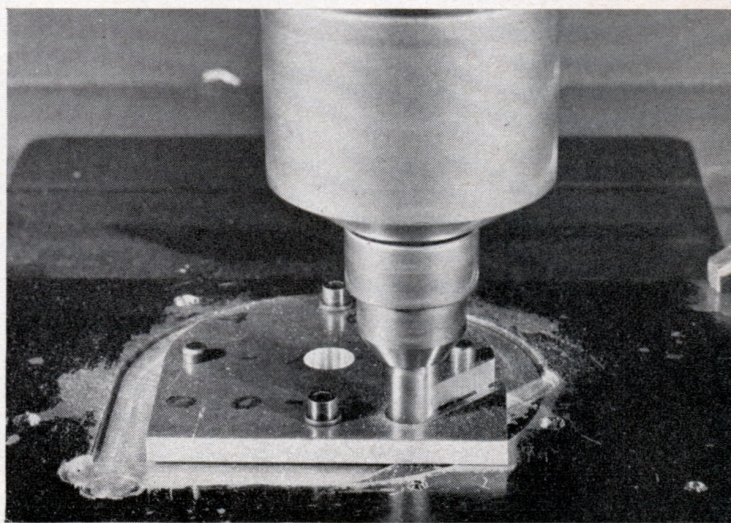
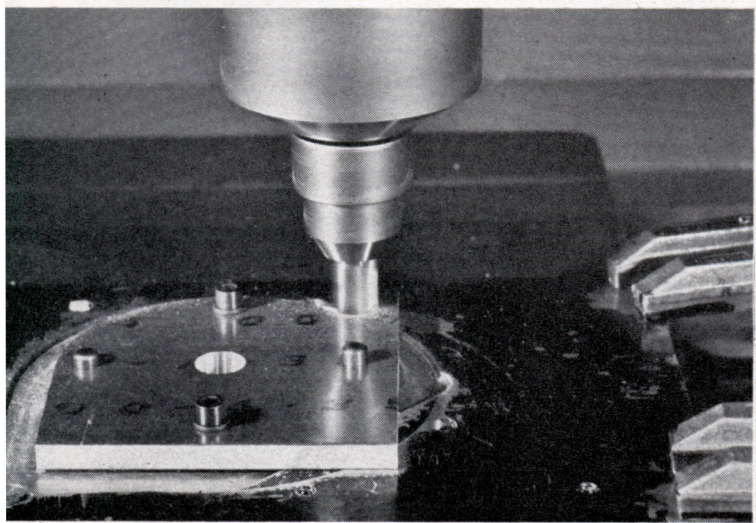
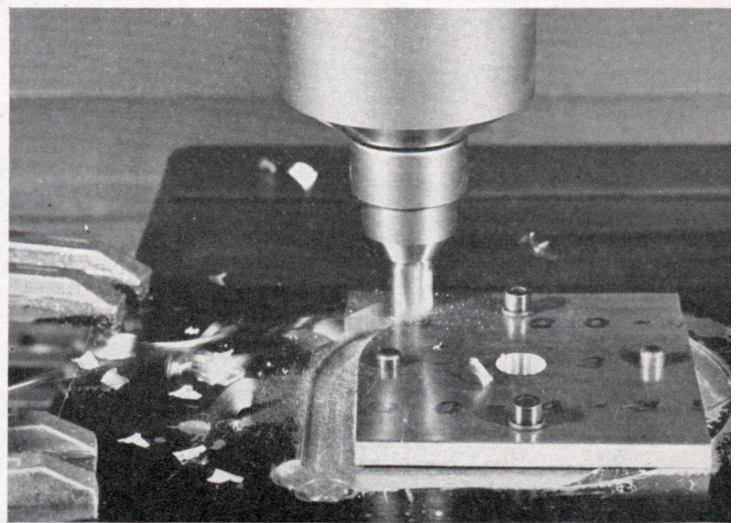
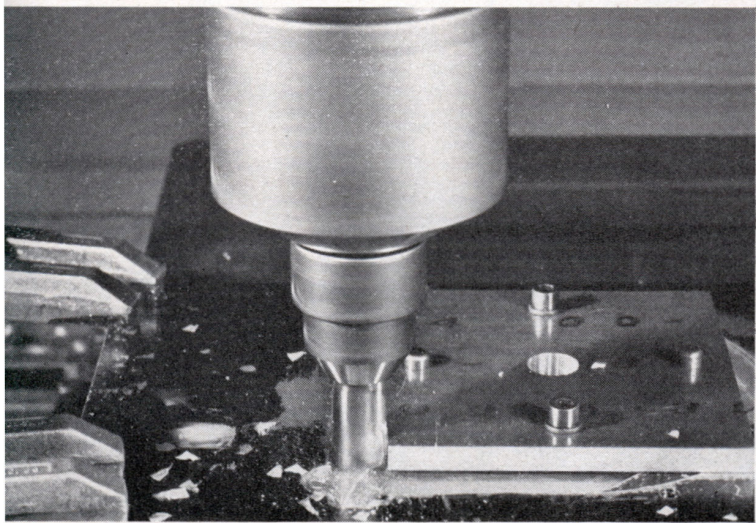
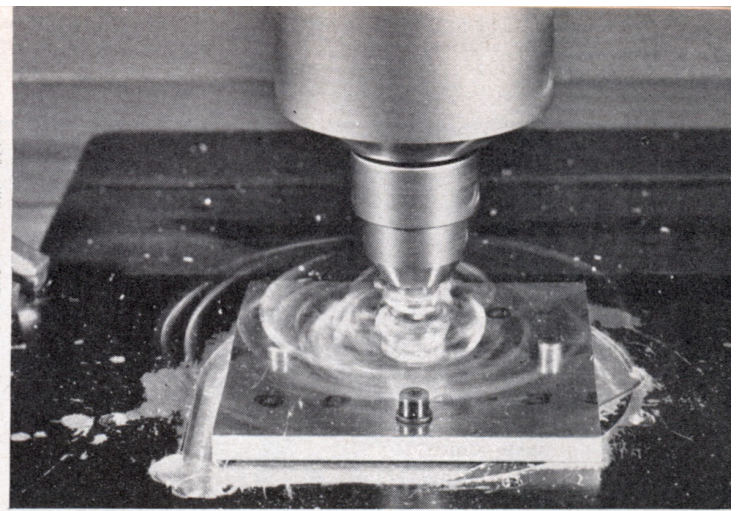
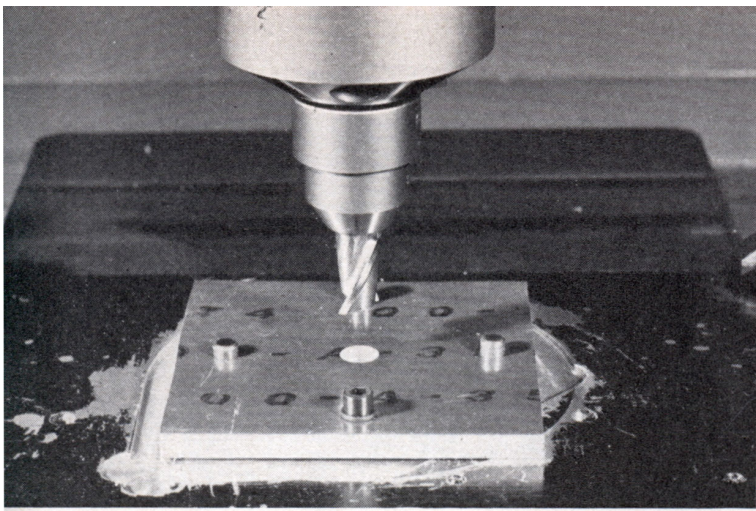

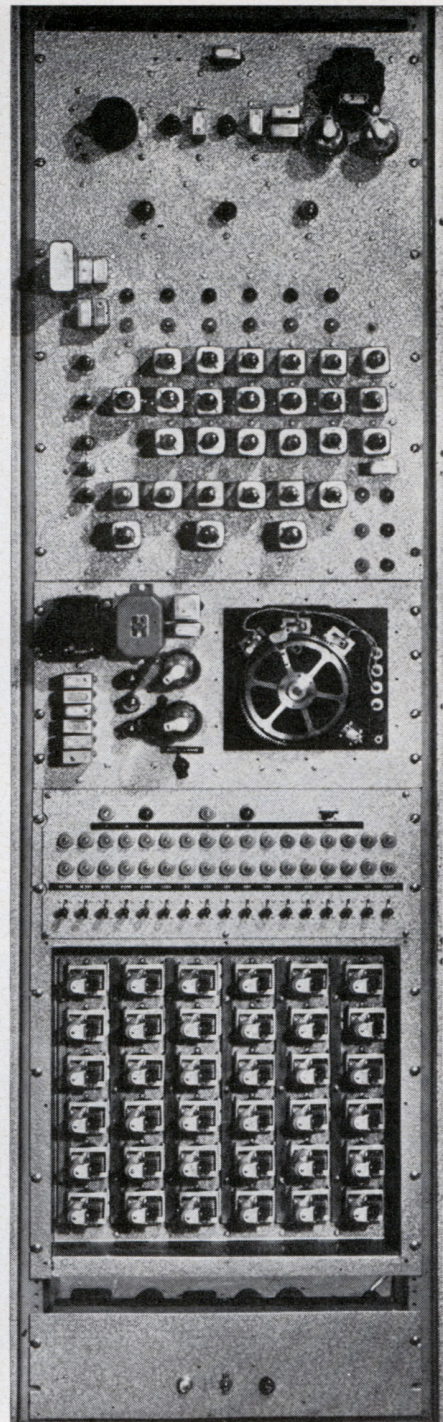
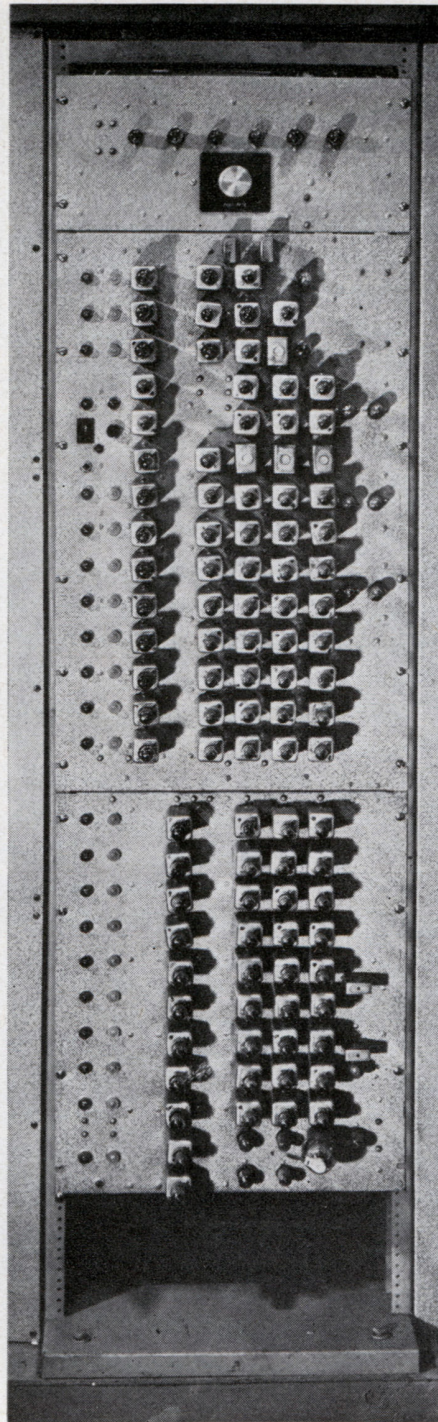
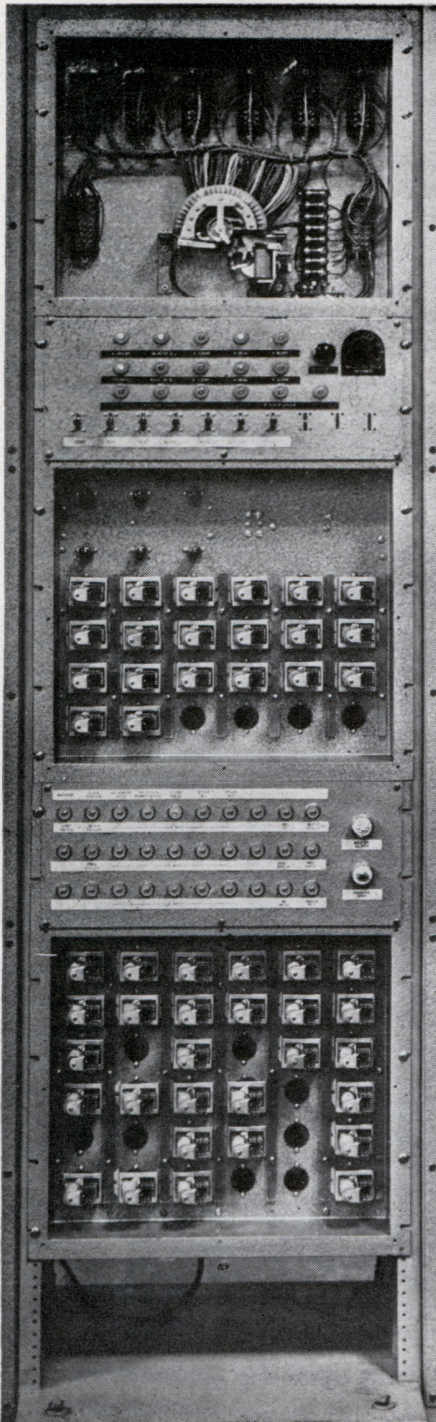

**CONTROL-SYSTEM** panel at left distributes commands to banks of relays in three panels at right, one for

ing made little money from the cotton gin, set up in New Haven as a manufacturer of muskets for the U. S. Government. He employed on this contract the interchangeable system of manufacture which was at that time still considered impractical by most experts. In fact, two years later it was necessary for Whitney to go to Washington to reassure the Secretary of War and officers of the Army that his idea was sound. Displaying 10 muskets, all tooled as nearly alike as he could make

each motion of the machine. An electronic oscillator "clock" at top of second panel generates steady flow

them, he showed that the gun parts could be interchanged among all 10 without affecting the guns' operability. He went on to prove in his New Haven shop that precision machinery operated by relatively unskilled labor could make parts accurately enough for interchangeability, so that expensive handwork was no longer required.

Whitney's idea was received with skepticism, but it eventually won out. Interchangeable manufacture is a fundamental principle of all quantity pro-

of pulses. These are blocked or passed on by flip-flop switches in data-interpreting system below clock,

duction as we know it today. Automobiles and washing machines, typewriters and egg beaters—every common machine we use is manufactured with interchangeable parts.

The two primary tools of interchangeable manufacture are the lathe and the milling machine. The modern lathe owes its form mainly to Maudslay, but about 1854 the addition of the tool-changing turret equipped the lathe and its cousin, the automatic screw-cutting machine, for interchangeable manu-

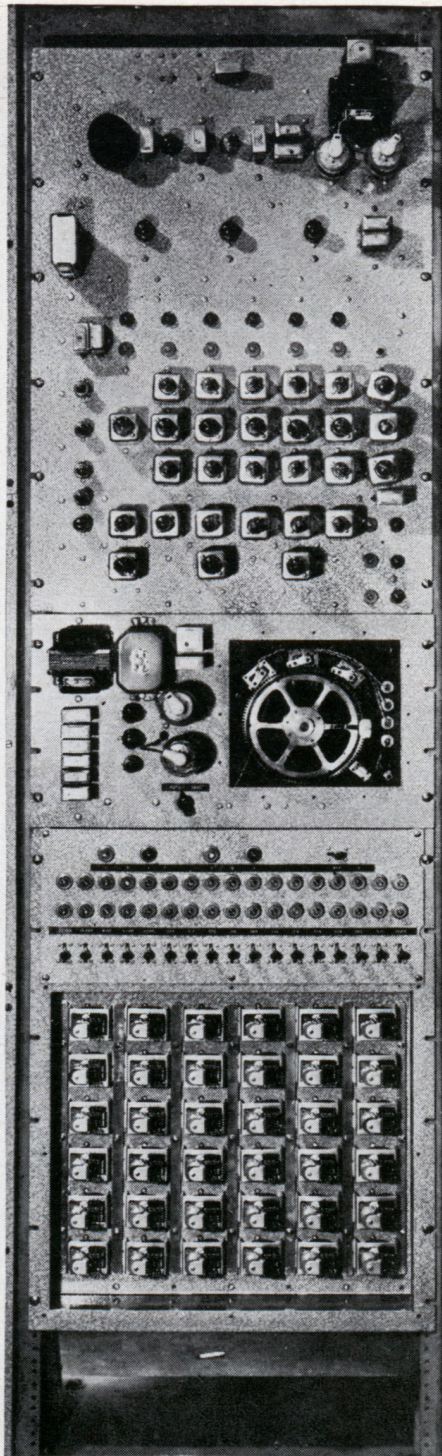
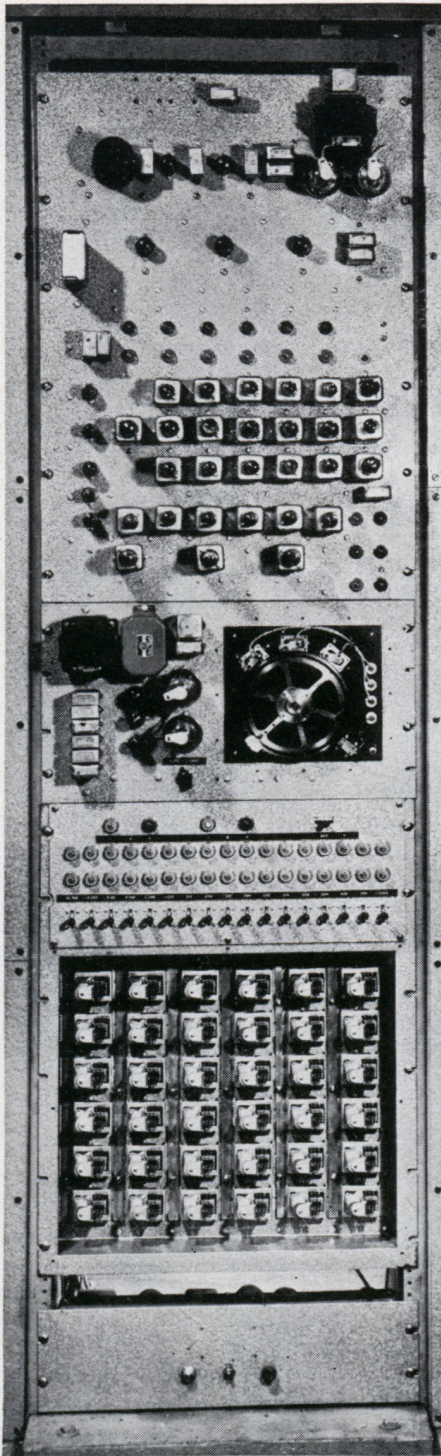

in accord with commands stored in relays. Now coded in pulses, commands flow to decoding servo-mech-

anism. The first milling machine suitable for interchangeable manufacture was built by Whitney. In 1862 the Providence inventor Joseph R. Brown developed the universal milling machine, the type in common use today. To these basic tools the 19th century added machines for drilling, punching, sawing and shaping metal.

In a sense the guides, tracks and other devices built into machinery to raise its precision level are a kind of automatic control. This type of autom-

anism in three panels at right. These convert pulses into continuously varying signals that drive machine.

atism is no new concept in the metal-cutting industry. From the beginning machine tools were created to reduce the amount of human skill required in manufacture. These automatic aids to proficiency, always adhering to the double principle of accuracy for interchangeability and speed for economy, have increased through the years.

**F**LEXIBLE MACHINES, capable of manufacturing a wide assortment of parts, are an essential part of modern

**Potter** HIGH SPEED  
ELECTRONIC COUNTERS  
INDISPENSABLE TO THE

**AUTOMATIC  
FACTORY**

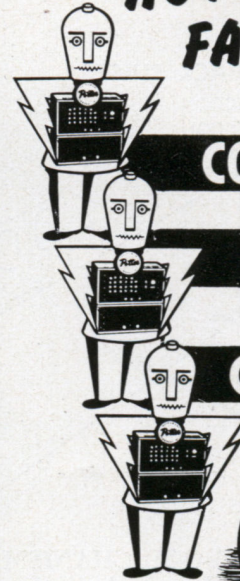

FOR  
**COUNTING**

**TIMING**

AND  
**CONTROL**



**MACHINE AND PROCESS CONTROL**

Potter High Speed Predetermined Electronic Counters are being applied to automatic control of a wide variety of machines and processes. The Counters are used to provide control action after a measure of Quantity, Dimension, Time, Revolution—or any count-producing action. The program, representing a sequence of predetermined counts, is set up on digital dial switches. Where a large number of steps is involved, the program of predetermined counts and control action can be sent from punched tape, cards or magnetic tape. Potter Electronic Counters are inertialess, there is **NO MECHANICAL WEAR!** Counting at rates over 1,000,000 per second—with absolute accuracy—is possible.

**PRODUCTION AND INVENTORY  
CONTROL**

The Potter Instrument Company also supplies complete **PRODUCTION AND INVENTORY CONTROL SYSTEMS** utilizing a radically new Random Access Memory (RAM), electronic computer circuitry and a high speed printer (Flying Typewriter).

FOR AN ENGINEERING OR SYSTEMS APPRAISAL OF YOUR PROBLEM, WRITE OR CALL DEPT. 9A

**POTTER  
INSTRUMENT COMPANY**

INCORPORATED  
115 CUTTER MILL ROAD, GREAT NECK, L. I.

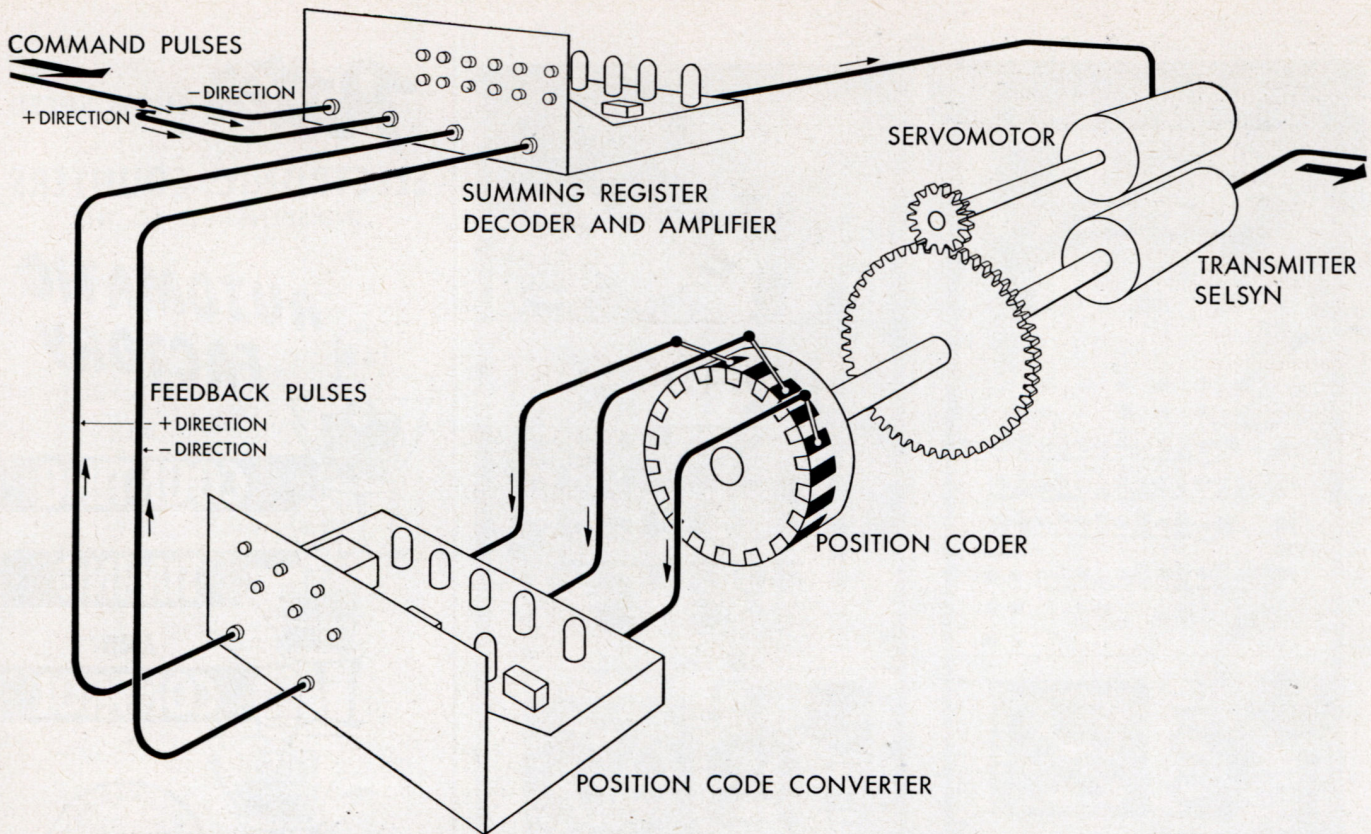

**DECODING SERVO-MECHANISM** ensures that commands are correctly translated from pulse form into the analogue form of a varying shaft angle. Pulses from amplifier cause servomotor to rotate the transmitter

shaft one degree per pulse. Rotation is sensed by brushes on position coder, which feed back one pulse to amplifier for each degree of rotation. Transmitter selsyn converts shaft motion into varying electrical signal.

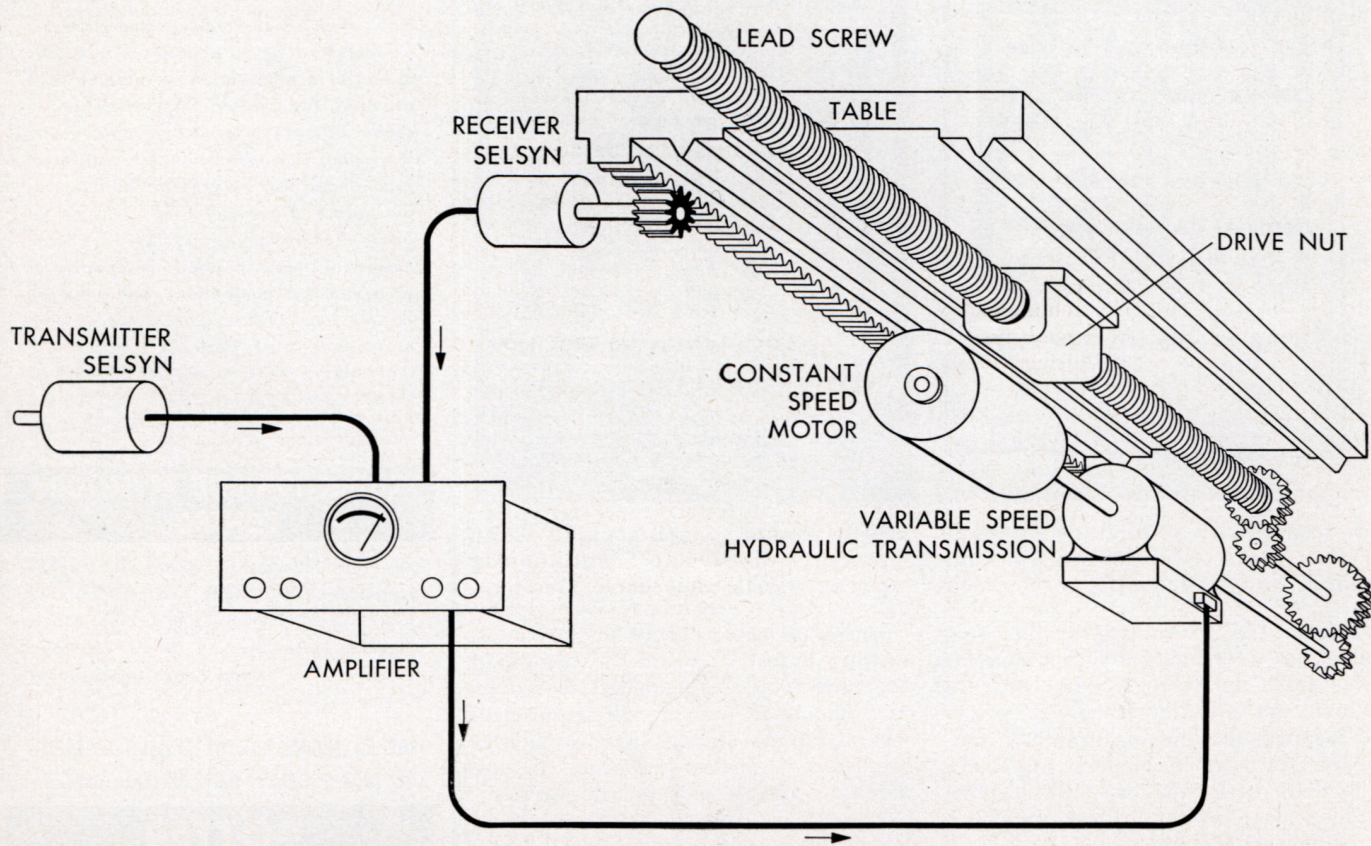

**MACHINE-DRIVE SERVO-MECHANISM** ensures that commands in the form of a varying electrical signal from decoding servo-mechanism transmitter are correctly reproduced by the motions of the milling ma-

chine. Receiver selsyn under table at right feeds back to amplifier a signal corresponding to the motion of the table. This signal is compared with the transmitter signal and a corrected signal is sent to the table drive.

manufacturing technique. The reason why they have thus far been untouched by automatic control can be given in terms of the concepts of information flow and feedback control.

A rough measure of the cost of automatic control is the amount and nature of the information the automatic machine must handle. To perform a complicated operation such as manufacturing a metal part, we must build into the machine a great deal of information-handling capacity, for it has to carry out a whole complex of instructions. This initial equipment is expensive. If the machine is to manufacture only a single product, say an automobile crankshaft, in large quantities, the investment is spread over many items and the cost of each crankshaft is small. In such a case the automatic machine is worth its cost.

But suppose we want an automatic machine which will make not one particular product, or part, but a number of different kinds of products, and only a few of each—as the versatile machine tool must do. Now the machine must handle a different set of instructions for each product, instead of the single set of instructions for the crankshaft. In other words, it must be able to deal with more information. And the cost of the information-handling capacity needed for each product is spread over only a few items instead of many. This is the essential problem in automatizing machine tools.

Obviously one way to attack the problem is to economize in the information requirements of the machine for the various operations. What are these requirements? To begin with, the machine tool must orient itself continuously toward the material on which it is working; if it is to drill a hole in a piece of metal, it must drill the hole in the right place and to the right depth.

Early in their history machine tools began to acquire automatic feed mechanisms. Maudslay's screw-cutting lathe, which controlled precisely the distance that the cutting tool was advanced for each revolution of the work piece, was an expression of this principle. Another step toward automatization was Thomas Blanchard's invention in 1818 of the "copying" lathe for turning gunstocks—the first of a class of tools now known as "cam-following" machines. This type of tool is automatically oriented to machine irregular shapes. The information required to specify the irregular shape is stored in a cam built to represent that shape. An important weakness of these machines is that all the force required to position the cutting tool is furnished by the cam itself. It is costly to build a mechanism strong and accurate enough to transfer motion from the cam to the work piece, and the cam wears out.

Feedback control made its first sig-



## AUTOMATIC CONTROL

VENUS FLY TRAP

### ... AND SIGMA SENSITIVE RELAYS

Many control systems use relays to perform a switching function responding to electronically computed problem solutions. Sigma makes relays that will do a good job as slaves in such systems.

A Sigma specialty, however, is the design of relays to perform an integral part of the computation. Here are some of the ways that Sigma Sensitive Relays may be used in such a manner.

#### MEASUREMENT OF ONE VARIABLE

Sigma Sensitive Relays can measure the fluctuations in system variables (when the variables can be converted into changing voltage or current) and initiate proper response.

*Example:* In the control of boiler water salinity, Sigma Relays are used to measure changes in current flow between two electrodes. When salinity exceeds certain limits, the relay notes the resultant drop in electrical resistance and initiates corrective measures.

#### COMPARISON OF TWO VARIABLES

Sigma Sensitive Relays with two coils may be made to respond to the difference of two variables (expressed electrically), regardless of their magnitude.

*Example:* In the control of aircraft cabin temperature, Sigma Relays receive signals from a number of different temperature pickups and compute the required heat delivery to provide stable and constant temperature.

#### MODULATION—AMPLIFICATION

Sigma Sensitive Relays can be used to convert an electrical variable into a variation in width of continuously transmitted pulses of high power level.

*Example:* In servo systems a polarized relay is energized with a small AC signal and vibrates to close first one then another circuit. A separate DC signal controls closed-time ratio, thus total power ratio. A motor may thus be controlled as to speed and direction.

If you have a problem where a "discriminating" relay would help, be sure to let us know about it.

# SIGMA

SIGMA INSTRUMENTS, INC.

40 PEARL ST., SO. BRAintree, BOSTON 85, MASS.

# automatic voltage regulation

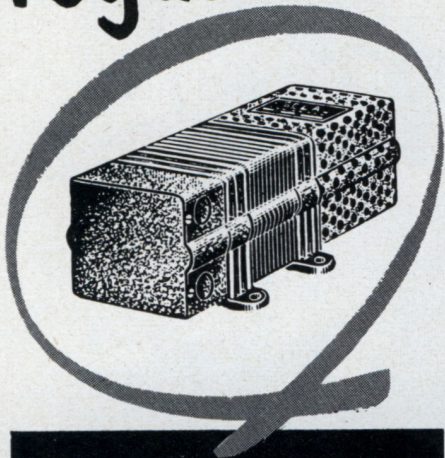

**for Automatic Process  
Control and Research**

Stabilized voltage is essential for proper performance of most electronic equipment. Sola Constant Voltage Transformers provide secondary voltage stabilized within  $\pm 1\%$  with primary voltage variations as great as 30%.

They are static-magnetic regulators . . .  $\pm 1\%$  regulation completely automatic and continuous . . . no tubes, moving parts or adjustments . . . response time 1.5 cycles or less. Twenty-nine standard sizes are available in capacities from 15va to 10kva . . . seven harmonic neutralized types from 30 va to 2kva. Special transformers to meet specific requirements can be designed and produced for on a quantity basis.

The entire line of Sola regulators is described in a 24-page catalog. Data covers electrical and mechanical specifications, operating data, special custom designs and applications. Write for Bulletin AA-CV-142.

# SOLA

*Constant Voltage*  
**TRANSFORMERS**

**SOLA ELECTRIC CO.**  
4633 W. 16th St. Chicago 50, Ill.

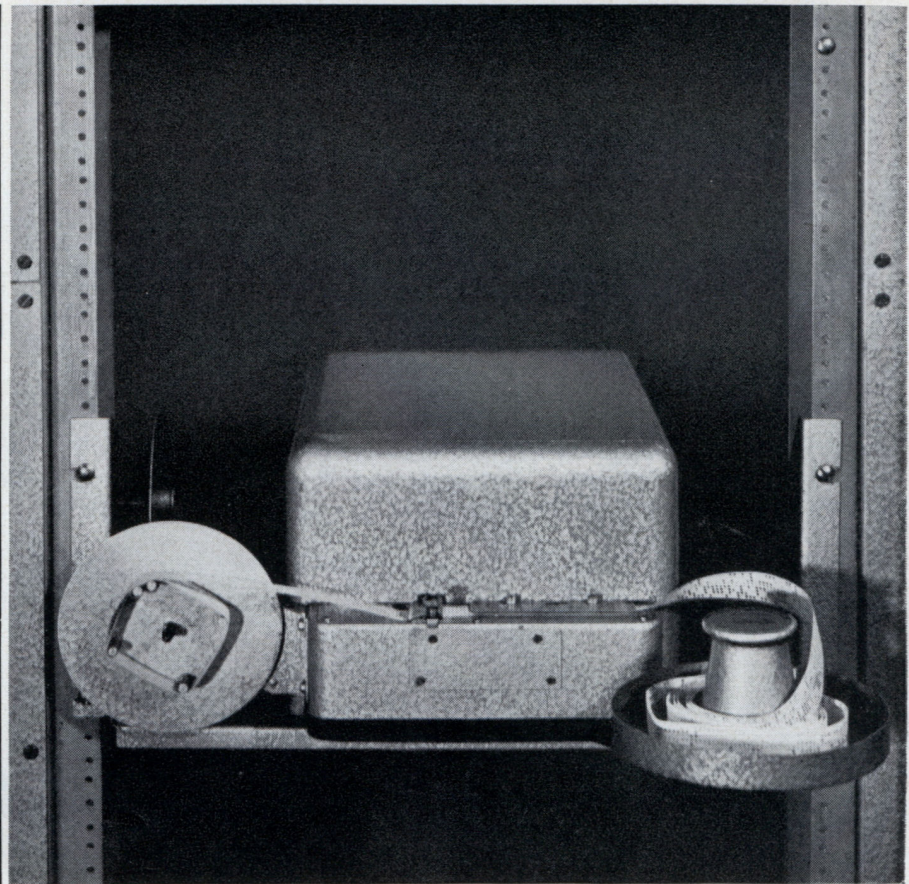

**TAPE READER** transfers commands from paper tape to relays in control system. Each punch hole closes a relay. Paper tape is not subject to dimensional instability which afflicts cams and other analogue controls.

nificant entrance into the machine-tool field in 1921, when John Shaw, working in the shop of Joseph Keller, invented the Keller duplicating system. In this system the information source is not a cam but a plaster-of-paris or wood model of the part to be machined. An electrical sensory device traces the model shape and transfers the information to the tool. By permitting the use of soft, easily fabricated models, the method reduces the cost of information storage. Modern versions of the dupli-

cating system are embodied in the die-sinking machines of the Pratt & Whitney Division of the Niles-Bement-Pond Company. An hydraulic form of it was originated by Hans Ernst and Bernard Sassen at the Cincinnati Milling Machine Company in 1930. Since World War II a number of manufacturers have developed systems of this kind, employing a variety of electrical, mechanical and optical devices.

A further step in the reduction of the cost of information storage and

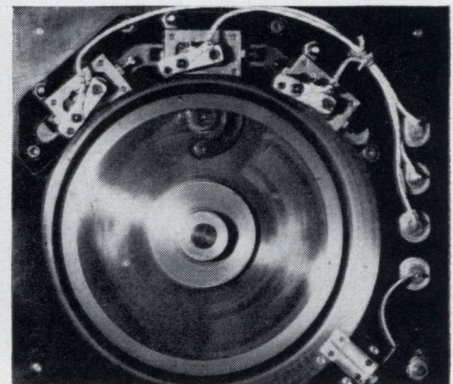
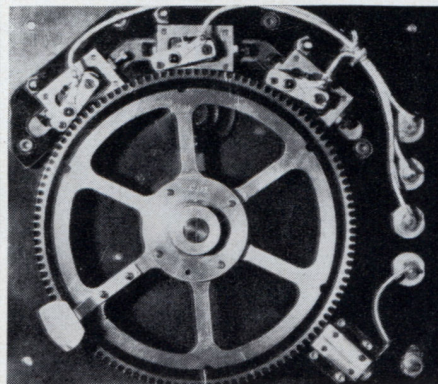

**POSITION CODER** translates the continuous rotation of the decoding servo-mechanism shaft back into pulse code. As the wheel spins, electrical contacts around its rim close circuits with brushes mounted above.



transfer is promised through the use of digital information processes. A number of applications of digital processes to machine-tool control are currently being made. Let us look in detail at one of the most ambitious of these completed this year at the Massachusetts Institute of Technology.

**T**HE M.I.T. system combines digital and analogue processes under feedback control to govern a milling machine whose cutting tool moves in three planes relative to the work piece. In this case the "model" of the object to be fabricated is supplied to the machine in the form of a perforated paper tape similar to that used in teletype systems. For a typical operation, 10 feet of tape will keep the machine busy for an hour.

The components of the M.I.T. system are grouped into two major assemblies. The first of these, called the "machine," comprises the milling machine itself, the three servo-mechanisms employed to operate its moving parts, and the instruments required to measure the relative positions of these parts. The second assembly, called the "director," contains all the data-handling equipment needed to interpret the information on the tape and to pass it on as operating commands to the machine. The director contains three major elements—a data-input system, a data-interpreting system and a set of three decoding servo-mechanisms.

The purpose of the data-input system is to take the original instructions off the tape and feed them into the interpretive and command elements of the director. It consists of a reader, whose metal fingers scan the tape and report the presence or absence of holes by electrical signals, and a set of six relay registers (two for each of the basic machine motions) which store and transmit this information in numerical form. The registers are supplied in pairs, so that while one of them is in control of the machine, the other can receive information from the tape. At the end of each operating interval, command is transferred instantaneously from one register to the other.

The data-interpreting system picks up the numerical instructions stored in the registers and transmits them as pulse instructions to the decoding servo-mechanisms. These pulses are generated by an electronic oscillator, the "clock," which acts as the master time reference for the entire system. By means of a series of flip-flop switches, and in accordance with the instructions stored in the registers, these pulses are sent on to each of the three decoding servo-mechanisms.

Up to this point in the process, information has been handled in digital form. The three servo-mechanisms now convert the instructions to the analogue



## WHITTLING DOWN THE "IMPOSSIBLE"

*... in modern automatic control*

Fit the component to the application—**not** the application to inflexible, standardized components!

This Transicoil policy of matching electrical and mechanical specifications exactly by skilled adaptation from

a broad, versatile line of basic component designs has played a big part in advancing the automatic control art. Control engineering horizons have been broadened. The difficult has been accomplished rapidly, and the "impossible" steadily whittled down.

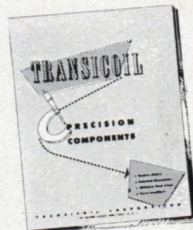

*This Booklet . . .* a complete guide to Transicoil components and services—is yours on letterhead request.

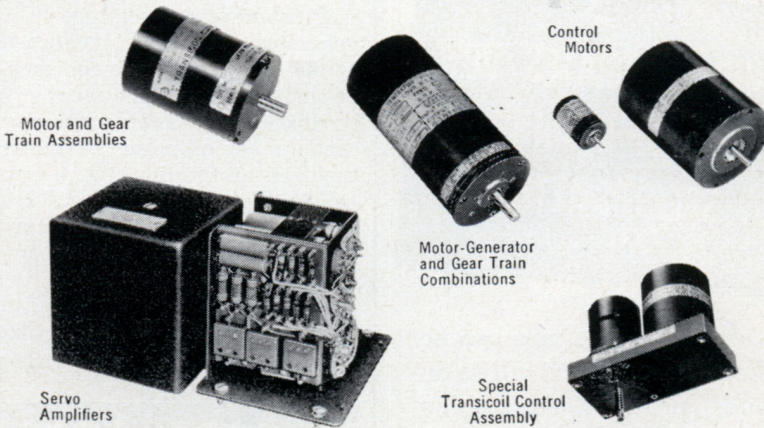

Motor and Gear Train Assemblies

Control Motors

Motor-Generator and Gear Train Combinations

Servo Amplifiers

Special Transicoil Control Assembly

# TRANSICOIL

PRECISION COMPONENTS

TRANSICOIL CORPORATION, 107 Grand St., New York 13, N. Y.

ENGINEERING-SALES REPRESENTATIVES IN:

Boston, Mass.; Buffalo, N.Y.; Chicago, Ill.; Cleveland, Ohio; Kansas City, Mo.; Los Angeles, Calif.; Minneapolis, Minn.; Netcong, N.J.; Philadelphia, Pa.; Phoenix, Ariz.; San Francisco, Calif.; Seattle, Wash.; Syracuse, N.Y., and Washington, D.C.

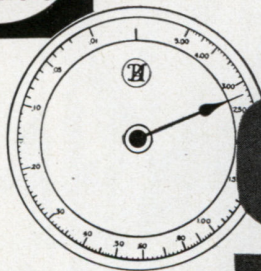

**DIRECT  
READING MEANS...  
DIRECT SAVINGS  
IN FURNACE CONTROL  
ANALYSIS WITH...**

**BAIRD ASSOCIATES - DOW  
DIRECT READING  
SPECTROMETER**

COMPLETE and precise analysis of complex alloys in seconds provides astonishing savings in production control. Send for Bulletin No. 34.

★ ★ ★

Baird Associates serves industry and science with a wide range of instruments for research and production control analysis. Discussion of your problems by letter or by personal interview is invited.

*Baird Associates, Inc.*  
33 UNIVERSITY ROAD  
CAMBRIDGE 38, MASS.

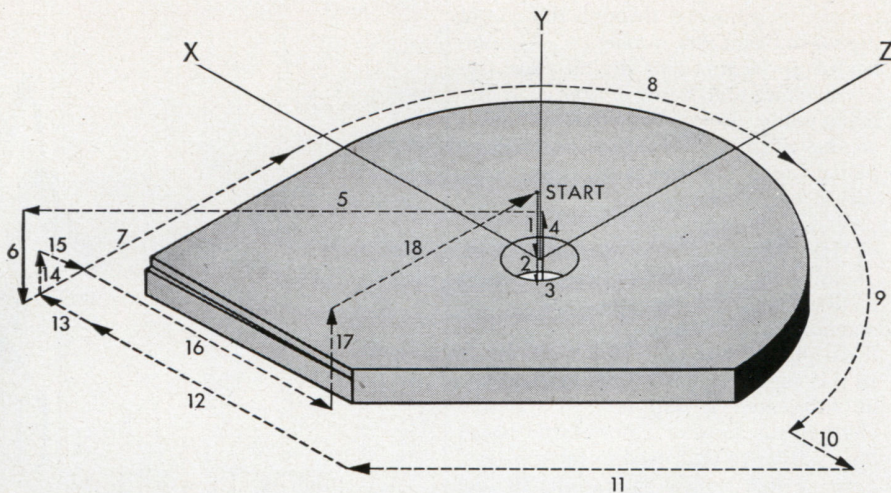

**WORK LAYOUT** breaks down cam-cutting operation into separate steps for encoding on instruction tape (*below*). Instructions for each motion of the machine may be computed directly from the engineering drawings.

form required by the machine tool. Pulses from the data-interpreting system are translated into the rotation of a shaft—one degree of rotation for each pulse. The shafts are connected to synchro transmitters which are themselves connected to the drive servo-mechanisms of the machine. A feedback circuit, inserted at this point in the director, makes certain that the conversion from digital to analogue information has been accurately carried out. It works as follows:

The mechanical element of each decoding servo-mechanism consists of the shaft connected to the synchro transmitter, a unit called a "coder" and a small two-phase induction servo-motor with appropriate gearing. The coder generates a feedback signal in the form of one electrical pulse for each degree of shaft rotation. The number of these feedback pulses is then compared with the number of pulses emanating from the data-interpreting system by a device called a "summing register." If the two counts agree, the summing register is at zero; if they do not agree, an electric voltage is generated and the two-phase servo-motor rotates the shaft to bring the count to zero. Thus a feedback path

makes certain that the output shaft position faithfully corresponds with the series of command pulses from the frequency divider. Information, coded first on tape, converted to digital and then to analogue form, is now transmitted to the working elements of the machine.

Each motion of the machine is accomplished by a lead screw driven by a hydraulic servo-mechanism (*see diagram on page 106*). The motor converts electrical commands received from the decoding mechanisms into the mechanical motions of the machine. Feedback is again introduced at the point of actual cutting to make certain that each element moves according to the instructions of its own decoding mechanism. A standard synchro receiver is coupled to each of the moving elements of the mill in such a way that each .0005 inch of tool travel causes the shaft of the synchro receiver to rotate one degree. The feedback signal derived from this shaft position is compared with the shaft position of the synchro transmitter at the decoding mechanism. Any difference of position between the two shafts appears as an alternating-current voltage which controls the speed of the hydraulic transmission. Thus the ma-

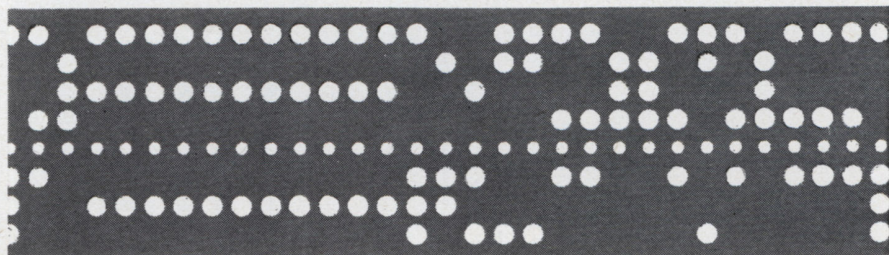

**TAPE** encodes commands in punch holes. The three lower horizontal rows contain commands for cross-slide, head and table motions, from top to bottom. Small holes in center engage sprocket drive of tape reader; four upper rows contain checking signals. The vertical line of four holes at either end and middle are "block" signals dividing commands into steps as shown in work layout above. Commands are for steps 6 and 7.

## WHAT'S IN IT

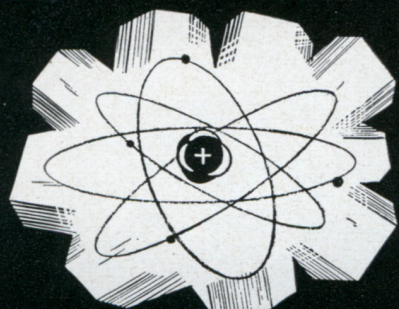

## FOR YOU?

Imagine an electronic instrument that would enable you to see into the very heart of materials and compute the exact percentages of each chemical element present, recording it on multiple copy sheets for your permanent records. Finally, if such a machine could analyze up to 20 elements of your choice *simultaneously* and give you the answer in *less than two minutes* you might well consider it miraculous.

### Is there such a scientific instrument that will accomplish this for you?

Yes! Applied Research Laboratories, pioneers in direct-reading spectrochemical instruments, have such equipment for you now. Just think of the laboratory time and money that could be saved in routine control of production materials alone.

All types of industries and laboratories are successfully using ARL equipment today with substantial savings in production and control costs. Write today for information on the complete ARL line.

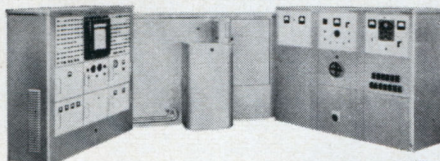

ARL Production Control Quantometer\*

ARL Raman Quantometer\*

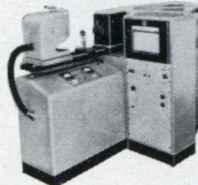

ARL products include: Production Control Quantometers\*, Raman Quantometers\*, 1.5 and 2-meter Spectrographs, Source Units and related accessories.

\*Trade Mark

 **Applied Research Laboratories**

SPECTROCHEMICAL EQUIPMENT  
3717 PARK PLACE • GLENDALE 8, CALIFORNIA  
New York • Pittsburgh • Detroit • Chicago • Los Angeles

chine element follows continuously the rotations of the synchro transmitter in the ratio of .0005 inch of linear travel to each degree of rotation.

**H**OW ARE the instructions for the machine's job put on the tape? The desired path of the cutting tool over the work is reduced to incremental straight-line segments; the segments are specified by numbers, and these are then translated into a code which can be punched on the tape.

The cutting path and the speed at which the work is to be fed to the machine are based on a number of factors: the amount of stock to be removed, the sequence of the machining operations, the setup of the work on the machine, spindle speeds, and so on. After the human operator determines the locus of the cutter center which will produce

the desired cutting path, he divides the locus into a series of straight-line segments. They should be as long as possible without differing from the ideal tool-center locus by more than the machining tolerance. The dimensions of each straight-line segment are then resolved into components parallel to each of the three directions of motion of the machine. For each straight-line segment, a time for execution is chosen to produce the desired feed rate. All this—the cutter motions and the time—is tabulated in a predetermined order to form a single set of control instructions. A separate set of instructions is made for each segment, in the order in which they will be used by the machine. The instructions, translated into patterns of holes, are punched in the paper tape by a special typewriter keyboard.

By inserting a new reel of tape for

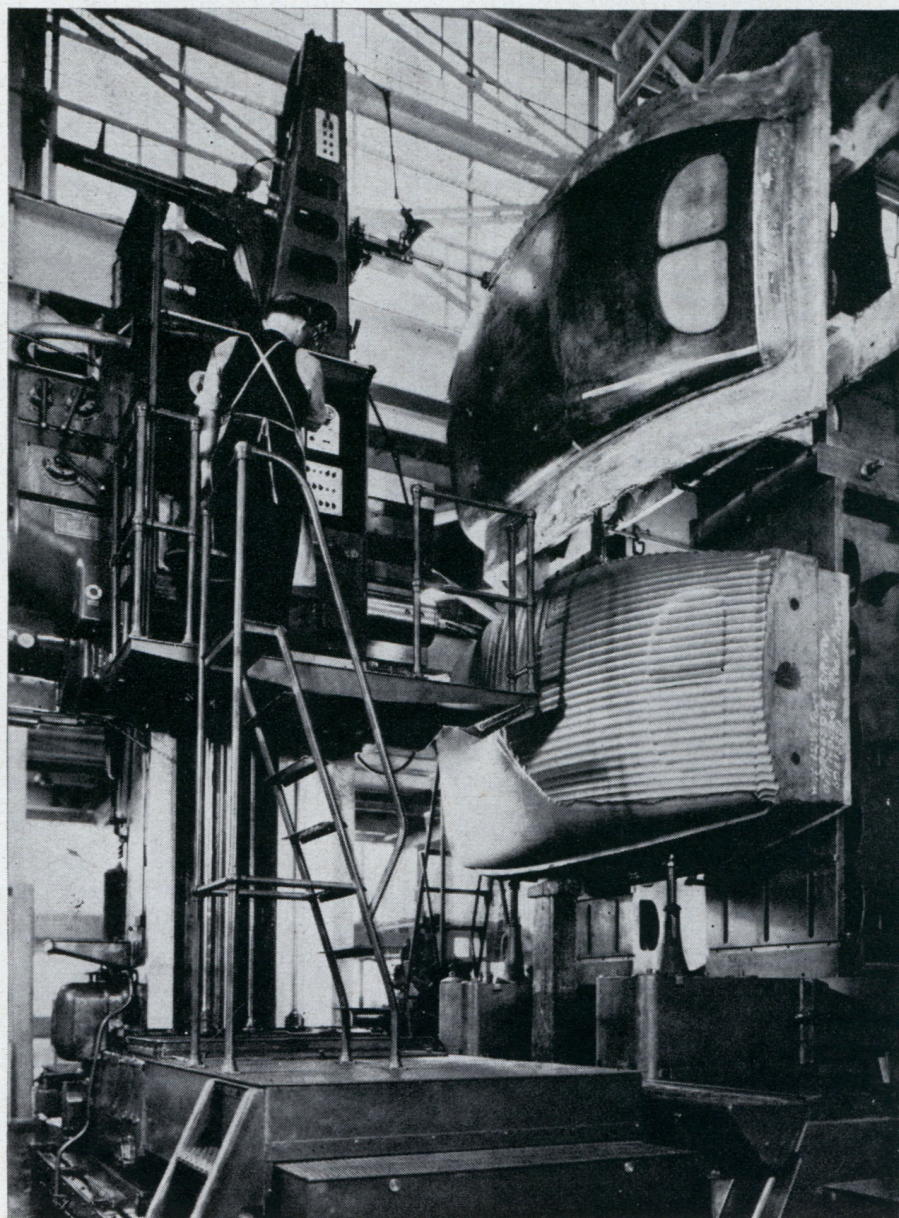

**KELLER MACHINE** shapes die for an auto top. Via a feedback loop, contour follower on surface of model at top guides cutting tool on work below.

# 3 NEW

## BAUSCH & LOMB TOOLS for RESEARCH and PRODUCTION

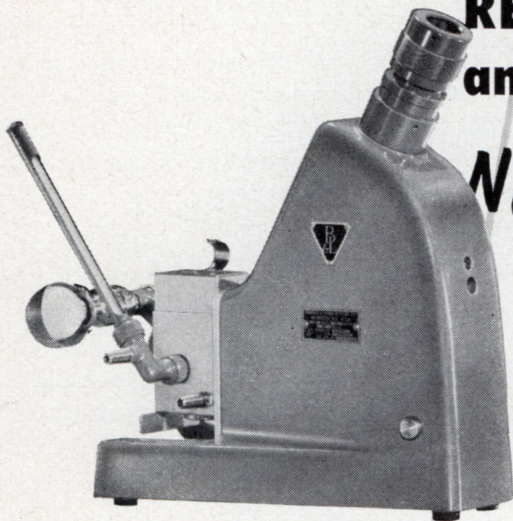

### NEW! INDUSTRIAL REFRACTOMETER

The world's fastest refractometer, accurate to  $\pm .0001$ . Saves time, materials and money by quicker readings — complete refractometric analyses in *seconds*. Sturdy design assures ample protection for precise optics, even under most unsatisfactory on-the-spot working conditions. Scales "tailor-made" to seven specific ranges industry requires. Write for Catalog D-258.

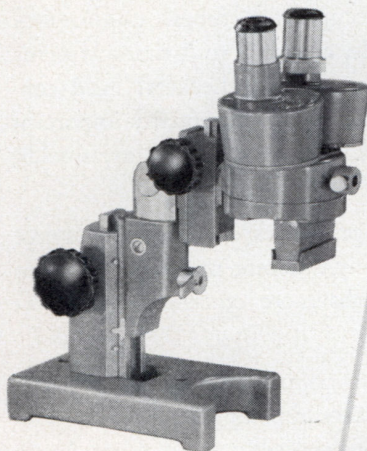

### NEW! INDUSTRIAL STEREOMICROSCOPE

Steps up production and increases accuracy in small parts assembly, and in inspection of tools and finished parts. Images are as natural-looking as though seen with the unaided eye—but *magnified*. Optional mountings for use in machine tools and inspection setups. Sturdy, dustproof, for practical use. Write for Catalog D-1029.

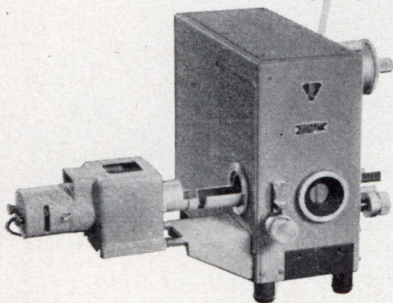

### NEW! GRATING MONOCHROMATOR

Efficiently produces intense monochromatic light of high spectral purity—less than .1% of stray light at 2650A. Choice of Certified-Precision Gratings, blazed for first order ultra-violet, and providing linear dispersion as high as 16A/mm. 2,000-14,000A range in first order. Adjustable slits. Available in 250mm and 500mm focal lengths. Write for Catalog D-259.

## WRITE

for complete information on how these three important optical aids can help solve your problems of analysis and production. Address Bausch & Lomb Optical Co., 78109 St. Paul St., Rochester 2, N. Y.

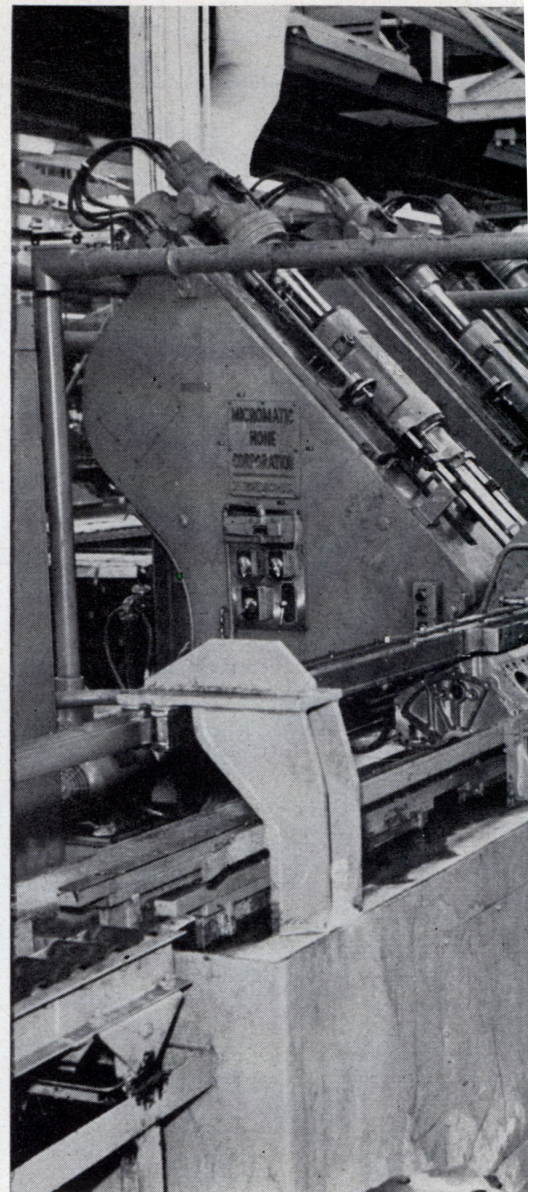

**AUTOMATIC TOOLS** in DeSoto engine line are designed to produce

each job to be performed, the milling machine can be converted from one manufacturing task to the next with little more effort than is required to change a phonograph record. And for every job that a given machine has ever performed, there is left a permanent record, in the shape of a tape containing full instructions. Another great advantage of the machine is that it produces continuously; unlike a machine tool run by a human operator, it does not need to be stopped for periodic measurements and adjustments.

**THE PERFORMANCE** of this M.I.T. model shows that fully automatic machine tools are not only possible but are certain to be developed in practicable form. It is surely startling (how much more startling it would have been to Maudslay and the other pioneers!) to think of versatile machine tools which



**Bausch & Lomb** *Industrial* Instruments

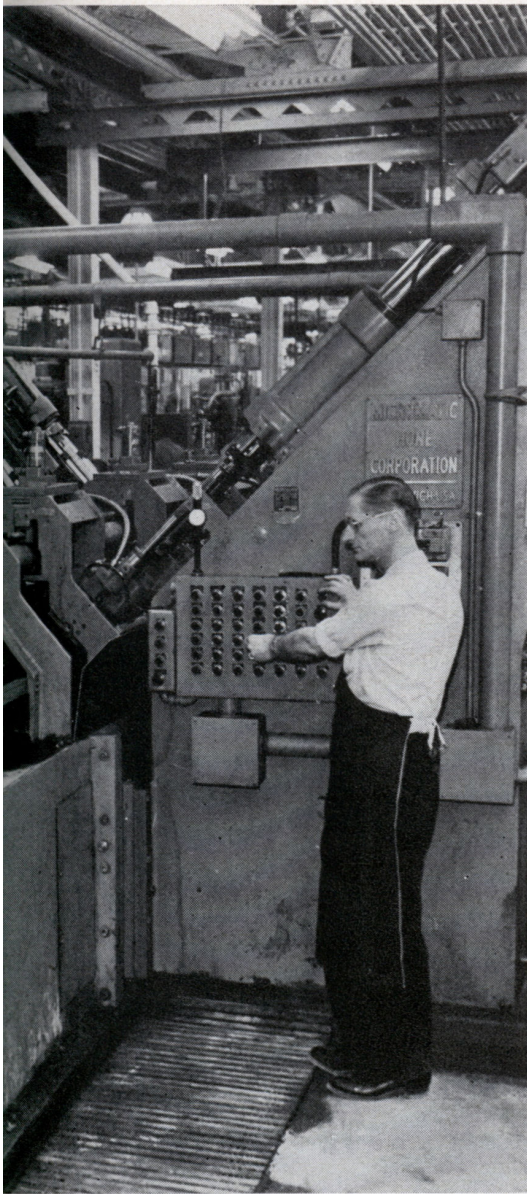

single product. Huge investment must be written off on mass production.

will perform any kind of work without the guidance of a human hand. The possible economic effects of such machines, on many industries besides metal-cutting, are beyond prediction. Automated general-purpose machine tools, combined with high-production special-purpose tools, would make possible the automatic metals-fabricating factory. Nor are we restricted to metals. With digital machines in control we can conceive of factories which will process, assemble and finish any article of manufacture.

It is unlikely that the automatic factory will appear suddenly. Like the machine tool itself, it will just grow by steps until eventually it is here.

*William Pease is associate professor of electrical engineering at the Massachusetts Institute of Technology.*

# New POTTER Electronic FLOWMETER and TACHOMETER

Improved design eliminates

- ★ BEARING MAINTENANCE
- ★ HIGH PRESSURE DROP
- ★ BEARING FRICTION



The improved Potter Electronic Flowmeter (patent pending) combines extreme accuracy with freedom from maintenance. This new design eliminates thrust bearings, high pressure drop, and bearing maintenance.

The Potter Flowmeter comprises a flow sensing unit having a hydraulically balanced rotor and magnet rotating within a compact non-magnetic housing, and an external pickup coil connected to an electronic integrator or totalizer, or both.

**ACCURATE within  $\pm 1/2\%$**

Since the novel, high-efficiency rotor spins in a freely balanced position within a venturi, its blades operate with practically no slippage. Fluid viscosity, pressure, temperature, and specific gravity only slightly affect the volumetric flow rate. Accuracy is maintained within  $\pm 1/2\%$ . Electric impulses from the rotor can be conducted to a combination electronic integrator and totalizer or other instrumentation. Rate of flow can be read or recorded either directly or remotely, and total flow is indicated on a resettable magnetic Veeder-Root counter.

Equipment is available with specific gravity compensation adjustment.

## POTTER Airborne FLOWMETER

Potter Single Range Airborne-type Flowmeter installation is compact and light in weight. Total weight of  $3/4$  in. sensing element, integrator with dust cover, and indicator operating on 115 volts ac, 400 cycles, is only  $4 7/8$  lbs. Equipment operating on 24-28 volts dc also available.

## APPLICATIONS

Potter Flowmeters accurately measure flow. Especially suitable for highly corrosive liquids, gases, acids, and liquid oxygen. We will gladly help you solve your flow measuring problems.

### SEND FOR NEW BULLETIN 1050

which gives full information, pressure drop chart, ranges, sizes, and operational data.

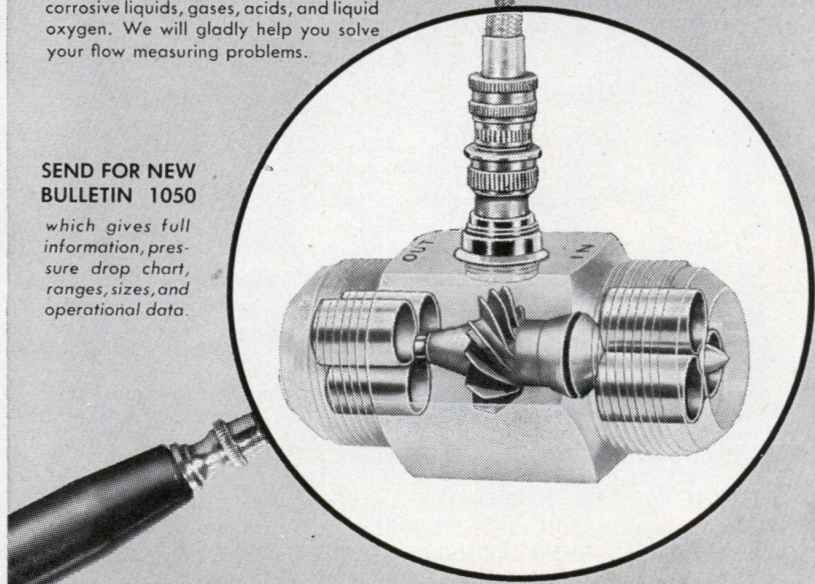

**POTTER AERONAUTICAL CO.** 87 Academy Street, Newark 2, N. J.